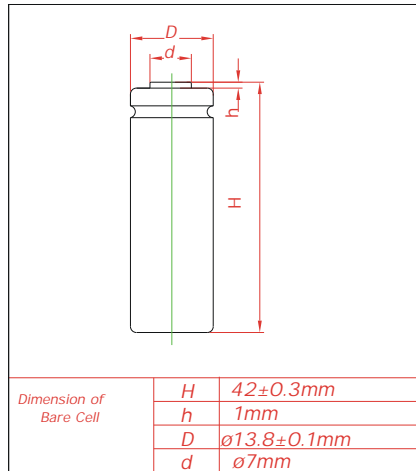
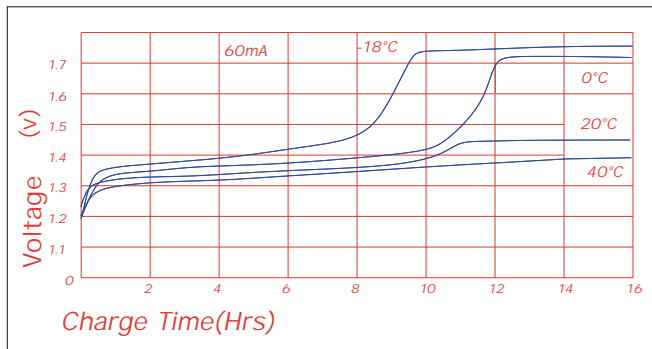
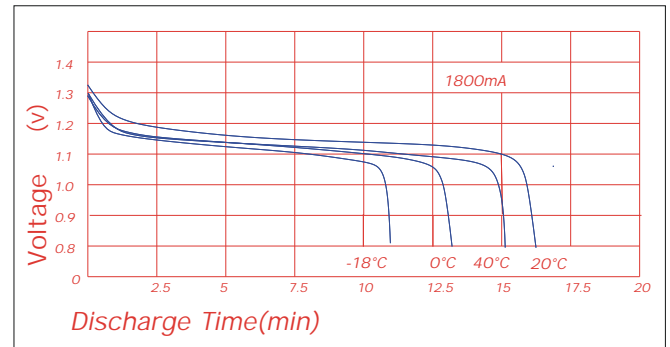
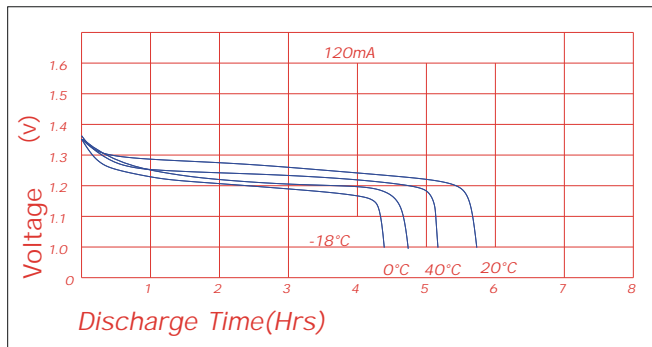
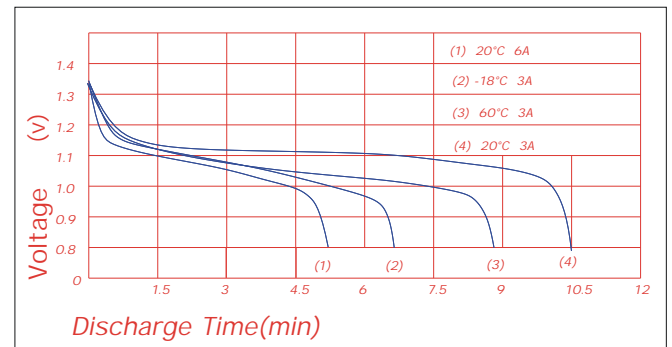
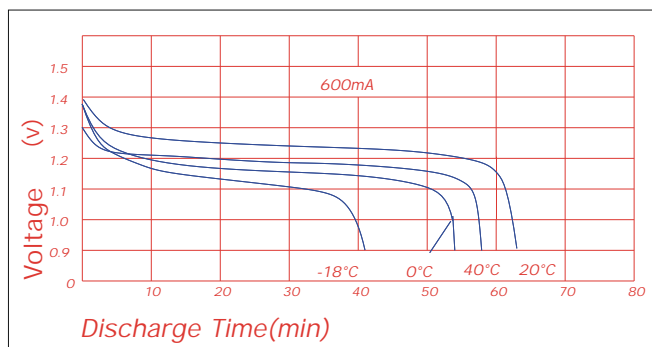

Specifications

Nominal Capacity		600mAh		
Nominal Voltage		1.2V		
Cycle life		>500		
Charge	Standard	60mA	15h	0-45°C
	Quick	180mA	5h	5-45°C
	Fast	600mA	1.1h	10-45°C
Discharge		-20°C~65-20°C		
Storage				
Internal Impedance(AC) (After Charge)		22m Ω		
Weight		21g		

Charge

Discharge(at high rate)

Discharge (at low rate)

Discharge(at high rate)

Discharge(at high rate)

Charge Retention
